

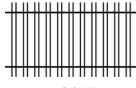

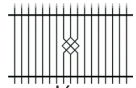







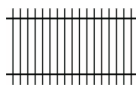

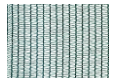
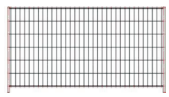

lesa
predaj plotov a brán

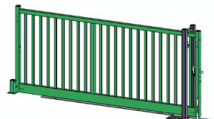
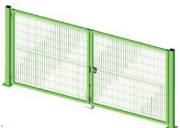
 onyx	 rubín str.11	 ametyst	
 agát	 smaragd	 gabión str.10	 tieniaca sieť
 mobilné oplotenie	 voliéra zvar	 uzlové	 voliéra 4-hr. str.9
 dekor	 brány k motorizácii str.8	 záhradné brány str.7	
 4-hr.pletivá+stĺpiky str.1-2	 zvár.v rolke + stĺpiky str.3-4	 zvár.panely+stĺpiky str.5-6	

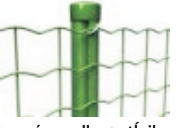









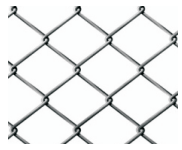
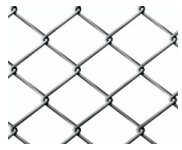
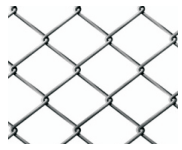

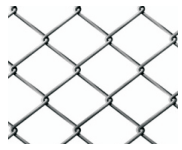

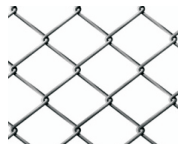

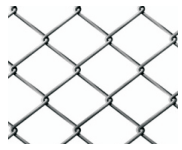

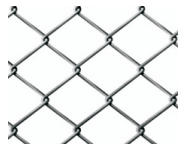
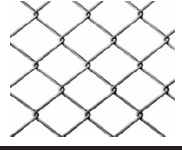
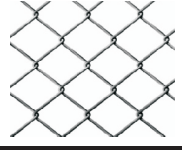

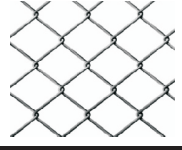

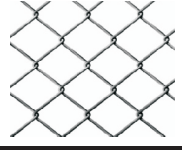

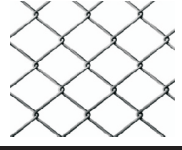

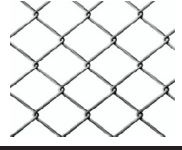
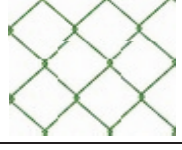
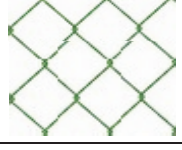

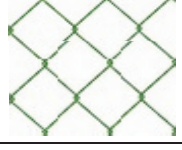

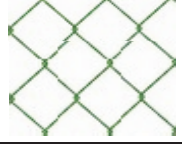

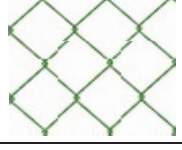

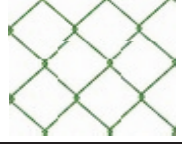













CENNÍK

platný od 1.5.2013

Ing.Jaroslav Dvorják
Teplička 263
052 01 Spišská Nová Ves

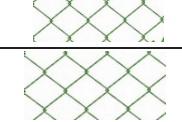
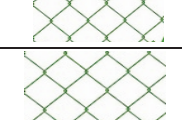
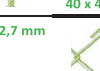
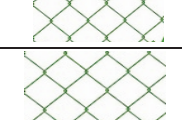









tel . 0918 240 615
www.predajplotov.sk
info@predajplotov.sk

PLETENÉ PLETIVÁ V ROLKÁCH



NÁZOV	Výška m	Dĺžka rol. m		hrúbka drôtu 2,1 mm	Cena za bm v €	
					bez DPH	s DPH 20%
4-HRAN ZN	1,00	25		hrúbka drôtu 2,1 mm	1,15	1,38
Štandard 60	1,25	25			1,40	1,68
oko 60x60 mm	1,50	25			1,70	2,04
Ø drôtu 2,15mm	1,60	25			1,80	2,16
pozinkované	1,80	25			2,05	2,46
	2,00	25		oko 60 x 60 mm	2,25	2,70
4-HRAN ZN	1,00	25		hrúbka drôtu 2,1 mm	1,30	1,56
Štandard 50	1,25	25			1,65	1,98
oko 50x50 mm	1,50	25			1,95	2,34
Ø drôtu 2,15mm	1,60	25			2,10	2,52
pozinkované	1,80	25			2,35	2,82
	2,00	25		oko 50 x 50 mm	2,60	3,12
4-HRAN PVC	1,00	25		hrúbka drôtu 2,5 mm	1,20	1,44
Light 60	1,25	25			1,45	1,74
oko 60x60 mm	1,50	25			1,75	2,10
Ø drôtu 1,65/2,4mm	1,60	25			1,90	2,28
Ral 6005 zelená	1,80	25			2,10	2,52
antracit,hnedá + 10%	2,00	25		oko 60 x 60 mm	2,35	2,82
4-HRAN PVC	1,00	25		hrúbka drôtu 2,5 mm	1,35	1,62
Light 50	1,25	25			1,70	2,04
oko 50x50 mm	1,50	25			2,00	2,40
Ø drôtu 1,65/2,4mm	1,60	25			2,15	2,58
Ral 6005 zelená	1,80	25			2,40	2,88
antracit,hnedá + 10%	2,00	25		oko 50 x 50 mm	2,70	3,24
4-HRAN PVC	1,00	20		hrúbka drôtu 3,0 mm	2,00	2,40
Štandard 50	1,25	20			2,50	3,00
oko 50x50 mm	1,50	20			3,00	3,60
Ø drôtu 1,9/3,0mm	1,60	20			3,20	3,84
Ral 6005 zelená	1,80	20			3,60	4,32
Ral 9005 čierna na obj.	2,00	20		oko 50 x 50 mm	4,00	4,80
4-HRAN PVC Tennis Light	1,00	25		hr.dr 2,5 mm	2,25	2,70
40x40 mm , 1,65/2,5mm	1,50	25			3,40	4,08
Ral 6005 zelená	2,00	25		40 x 40 mm	4,50	5,40
4-HRAN PVC Tennis	3,00	18		hr.dr 2,7 mm	10,30	12,36
45x45 mm , 1,8/2,7mm	3,50	18			11,50	13,80
Ral 6005 zelená	4,00	18		45 x 45 mm	13,70	16,44

Iné výšky a hrúbky pletív na vyžiadanie.





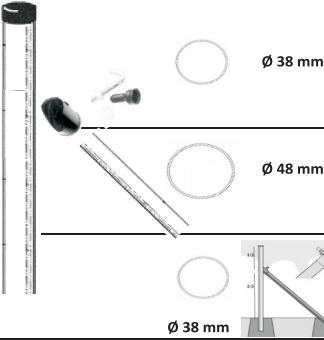
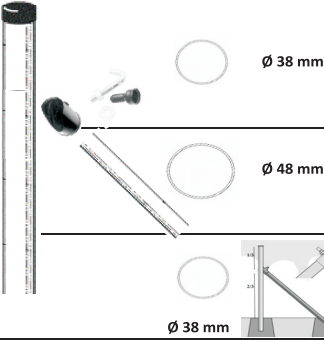
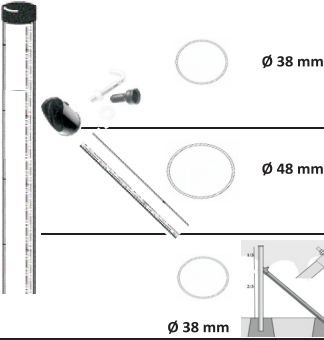
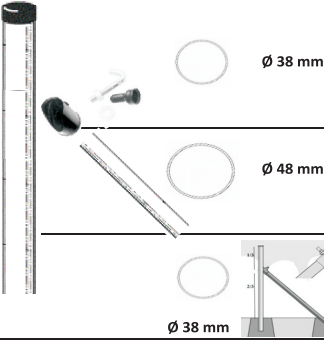
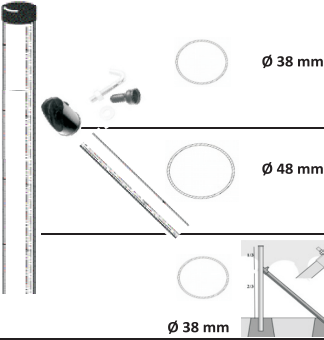
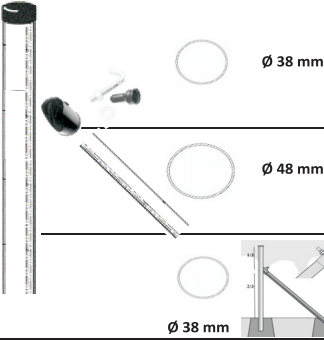
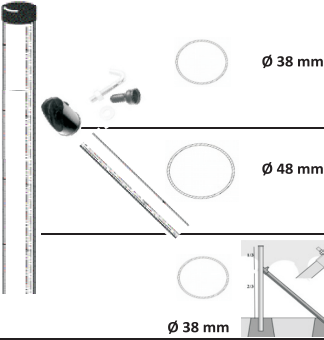
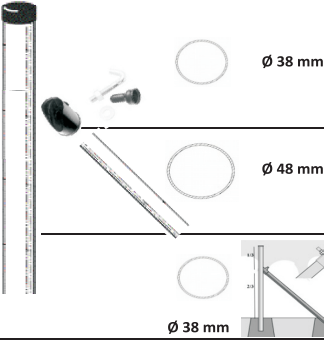
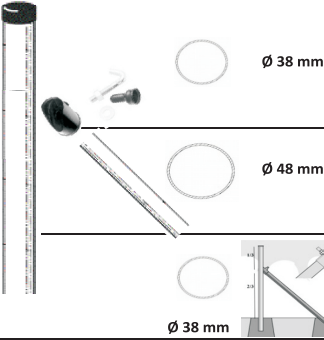
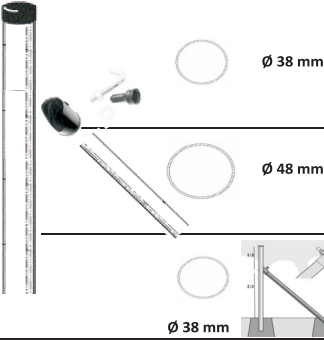
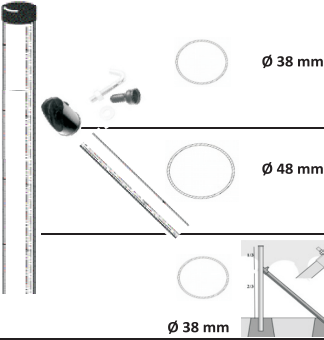
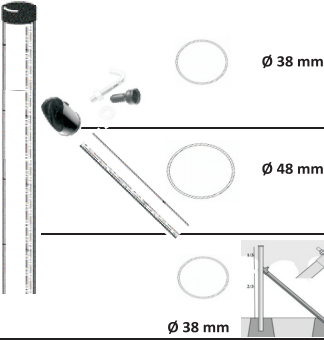
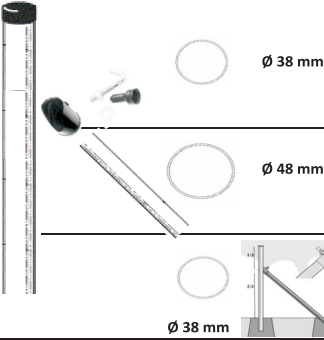
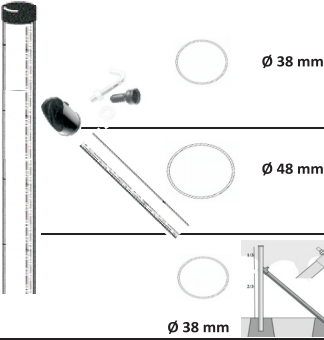
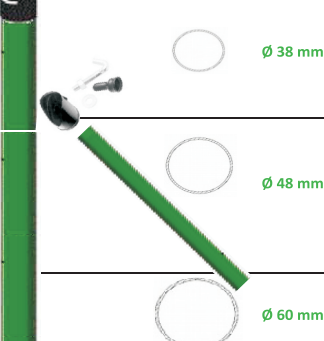
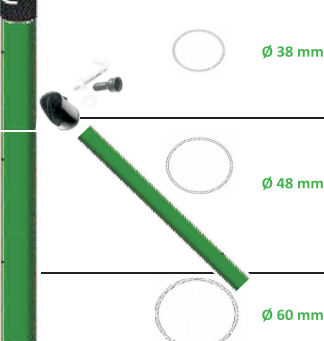
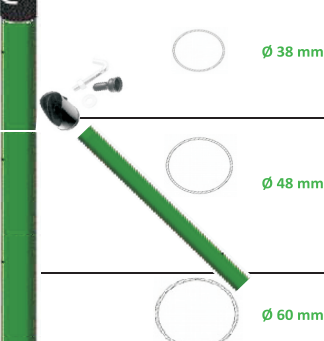
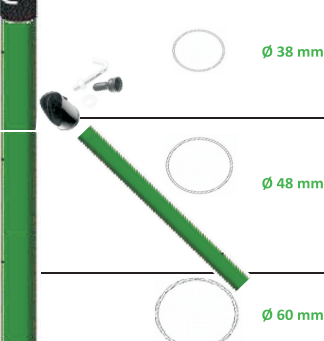
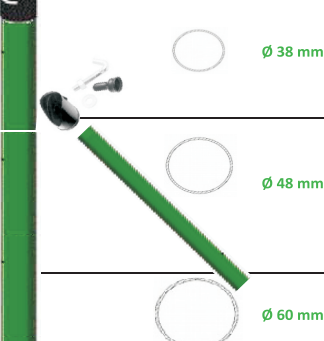
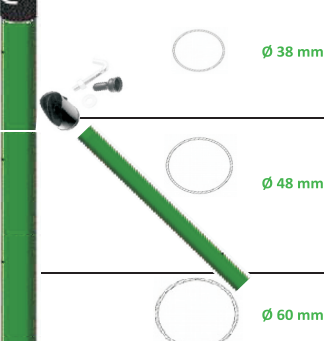
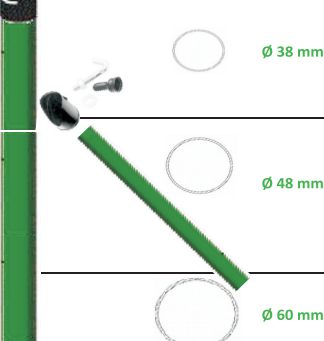
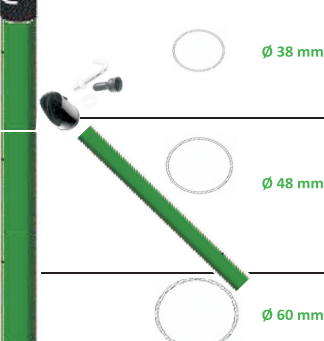
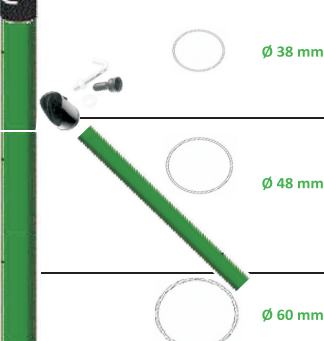
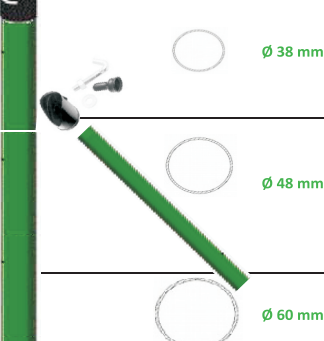
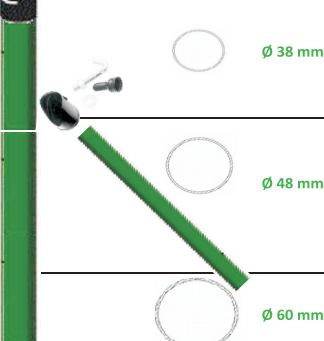
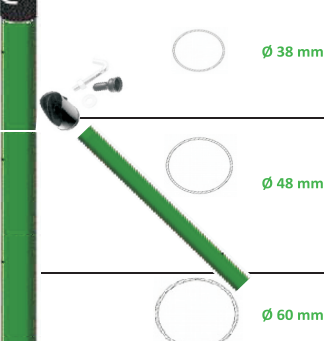
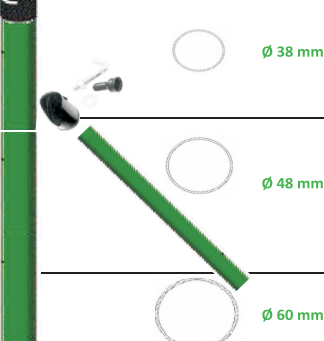
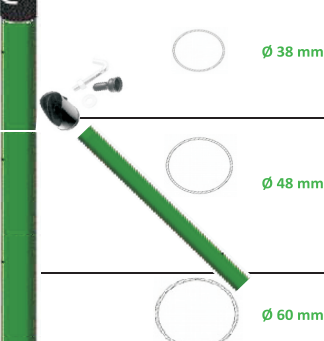
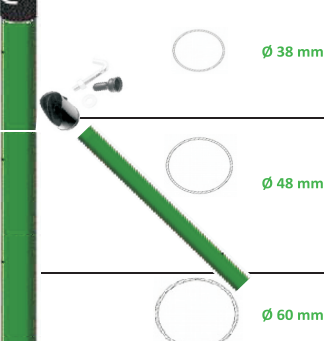
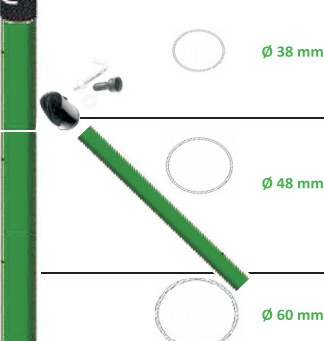
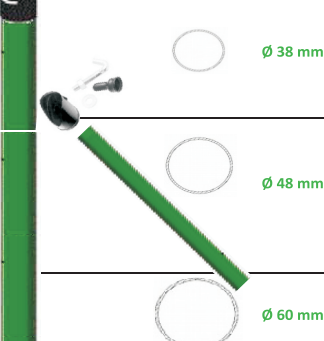
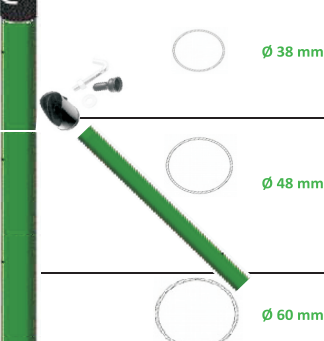

Príslušenstvo k pleteným pletivám :

Napínací drôt pvc	zelený	3,4/78m		7,70	9,24
Napínací drôt Zn	zelený	3,4/52m		5,95	7,14
	Zn	3,1/78m		6,75	8,10
Viazací drôt pvc	zelený	1,4/50m		1,25	1,50
Viazací drôt Zn	Zn	1,4/100m		2,25	2,70
Napinák pvc	zelený			0,45	0,54
Napinák Zn	Zn			0,50	0,60
***Spinky C-pvc	pvc	1000 ks		21,00	25,20
***Spinky C-Zn	Zn	1000 ks		14,00	16,80
Kliešte na C spinky	nahrádza viaz.drôt			13,00	15,60



KRUHOVÉ STÍPKY A VZPERY ZN a PVC / k 4-hranným pletivám/

NÁZOV	Ø / dĺžka mm/m	Výšk.opl. m		Cena v €	
				bez DPH	s DPH 20%
Kruhové stípkiky	38/1,50	1,00		0,00	-
ALFA Zn 38	38/1,75	1,25		0,00	-
Ø 38 mm	38/2,00	1,50		3,80	4,56
pozinkované	38/2,20	1,80		0,00	-
	38/2,50	2,00		4,70	5,64
Kruhové stípkiky	48/2,00	1,50		4,90	5,88
ALFA Zn 48	48/2,20	1,80		0,00	-
Ø 48 mm	48/2,50	2,00		6,00	7,20
pozinkované	48/2,80	2,20		0,00	-
Kruhové vzpery	38/1,50	1,00-1,20		0,00	-
38 Zn	38/1,75	1,20-1,50		0,00	-
Ø 38/35 mm	38/2,00	1,50-1,80		5,40	6,48
pozinkované	38/2,50	1,80-2,00		6,30	7,56
Kruhové stípkiky	38/1,50	1,00		3,50	4,20
ALFA pvc 38	38/1,75	1,25		0,00	-
Ø 38/40 mm	38/2,00	1,50		4,60	5,52
Ral 6005 zelená	38/2,20	1,80		0,00	-
	38/2,50	2,00		5,80	6,96
Kruhové stípkiky	48/1,50	1,00		4,90	5,88
ALFA pvc 48	48/1,75	1,20		5,75	6,90
Ø 48 mm	*48/2,00	1,50		6,60	7,92
Ral 6005 zelená	48/2,30	1,80		7,50	9,00
*Antracit + 10%	*48/2,50	2,00		8,20	9,84
	48/2,80	2,20		9,20	11,04
Kruhové stípkiky	60/3,75	3,00		30,00	36,00
ALFA pvc 60 - tenis	60/4,30	3,50		34,00	40,80
Ø 60 mm	60/4,90	4,00		38,00	45,60
Kruhové vzpery	38/1,50	1,00-1,20		5,10	6,12
38 pvc	38/1,75	1,20-1,50		0,00	-
Ø 38 /35/mm	*38/2,00	1,50-1,80		6,90	8,28
zelený/*antracit + 10%	38/2,50	1,80-2,00		8,30	9,96
Príchytky na stípkik	počet stípkikov x počet nap.dr.			0,17	0,20



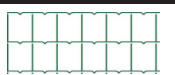
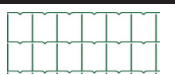
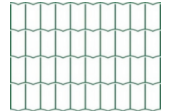
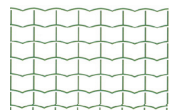
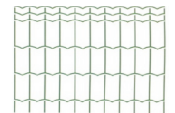
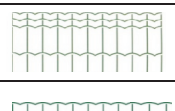
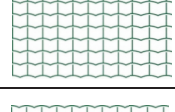
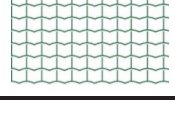

Príslušenstvo :

Pätka na stípkik /vzperu/	Zn / pvc zelená		10,50	12,60
Podhrabová doska	2490/250/35		15,00	18,00
dĺžka/výška/šírka	2590/250/35		16,00	19,20
mm	2490/500/35		28,00	33,60
Držiak podhr.dosky	plast Ø 50 mm		2,80	3,36
	hliník Ø 48 mm		7,00	8,40
Nástavec/bavolet	jednostranný I		7,50	9,00
Zn !!! iba 48 mm	obojsstranný V		15,00	18,00
Nástavec/bavolet	jednostranný I		8,50	10,20
PVC !!! iba 48 mm	obojsstranný V		17,00	20,40
Ostnatý drôt	Ø 1,8/2,00 - 50 m		8,50	10,20
Zn	Ø 1,8/2,00 - 100 m		14,00	16,80
	Ø 1,8/2,00 - 250 m		30,50	36,60
Ostnatý drôt PVC	Ø 2,0/2,50 - 100 m		19,00	22,80
Žiletkový drôt Zn	Ø 45 mm - cca 10 bm		22,00	26,40











ZVÁRANÉ PLETIVÁ V ROLKÁCH

NÁZOV	Výška m	Dĺžka rolky m		oko mm	Ø dr. mm	Cena za bm v €	
						bez DPH	s DPH 20%
ZVAR PVC Ultra Light oko 76x100 mm hr.drôtu. 1,7/2,1mm	1,00	25		oko 76x100	Ø dr. 2,1 mm	1,30	1,56
	1,20	25		1,60	1,92		
	1,50	25		1,90	2,28		
ZVAR PVC Light oko 50x100 mm hr.drôtu. 1,7/2,1mm Ral 6005 zelená	0,60	25		oko 50x100	Ø dr. 2,1 mm	0,95	1,14
	0,80	25		1,25	1,50		
	1,00	25		1,55	1,86		
	1,20	25		1,85	2,22		
	1,50	25		2,30	2,76		
	1,80	25		2,70	3,24		
2,00	25	3,05	3,66				
ZVAR PVC Medium oko 76x50 mm hr.drôtu. 1,7/2,1mm Ral 6005 zelená	1,00	25		oko 76x50	Ø dr. 2,3 mm	2,00	2,40
	1,20	25		2,25	2,70		
	1,50	25		3,00	3,60		
	1,80	25		3,50	4,20		
	2,00	25		3,80	4,56		
ZVAR PVC Štandard oko 50x100 mm hr.drôtu. 2,0/2,5mm Ral 6005 zelená	1,00	25		oko 50x100	Ø dr. 2,5 mm	2,35	2,82
	1,20	25		2,80	3,36		
	1,50	25		3,40	4,08		
	1,80	25		4,00	4,80		
	2,00	25		4,40	5,28		
ZVAR Antracit Štandar oko 100x50 mm 2,0/2,5mm ... Antracit	1,00	25		oko 50x100	Ø dr. 2,5 mm	2,60	3,12
	1,20	25		3,05	3,66		
	1,50	25		3,70	4,44		
ZVAR PVC Forte oko 50x50 mm 2,0/2,5 mm Ral 6005 zelená	1,00	25		oko 50x50	Ø dr. 2,5 mm	2,35	2,82
	1,20	25		2,75	3,30		
	1,50	25		3,85	4,62		
	1,80	25		4,20	5,04		
	2,00	25		4,80	5,76		
	2,00	25		4,80	5,76		
ZVAR PVC Super oko 50x50 mm hr.drôtu. 2,5/3,0mm Ral 6005 zelená	1,00	25		oko 50x50	Ø dr. 3,0 mm	4,10	4,92
	1,20	25		4,15	4,98		
	1,50	25		6,00	7,20		
	1,80	25		7,20	8,64		
	2,00	25		7,70	9,24		
	2,00	25		7,70	9,24		
LUX ZVAR PVC oko 76x76 mm hr.drôtu. 1,7/2,2mm Ral 6005 zelená	0,41	25		oko 76x76	Ø dr. 2,2 mm	1,90	2,28
	0,66	25		2,25	2,70		
	0,91	25		2,95	3,54		
	1,17	25		3,45	4,14		
	1,42	25		4,10	4,92		

Príslušenstvo k zváraným pletivám v rolke :





Šponovacie kliešte	profi		13,00	15,60
Viazací drôt pvc	zelený		1,25	1,50
Viazací drôt antracit	antracit		2,10	2,52
Spinky C-pvc	pvc		21,00	25,20
Spinky C-Zn	Zn		14,00	16,80
Kliešte na C spinky			13,00	15,60

KRUHOVÉ STĚPÍKY S NOSOM A VZPERY /k zváraným pletivám v rolkách/

NÁZOV	Ø / dĺžka mm/m	Výšk.opt. m		Cena v €	
				bez DPH	s DPH 20%
Stěpíky OMEGA Light 38 Ø 38 mm Ral 6005 zelené	38/1,50	1,00		5,20	6,24
	38/2,00	1,50		6,75	8,10
	38/2,25	1,80		7,50	9,00
	38/2,50	2,00		8,25	9,90
Stěpíky OMEGA 50 Ø 50 mm Ral 6005 zelená	50/1,50	1,00		6,70	8,04
	50/1,80	1,25		7,70	9,24
	50/2,00	1,50		8,70	10,44
	50/2,20	1,80		9,70	11,64
	50/2,50	2,00		10,70	12,84
	50/2,75	2,25		12,70	15,24
OMEGA 70 - ihrisko	70/5,00	3,0-3,5-4,0		37,00	44,40
	48/1,70	1,00 - 1,25		7,95	9,54
Stěpíky OMEGA 48 48 mm Ral 6005 zelená	48/2,00	1,50		9,25	11,10
	48/2,30	1,80		10,60	12,72
	48/2,50	2,00		11,50	13,80
	48/2,70	2,20		12,35	14,82
	48/3,00	2,50		13,70	16,44
Kruhové vzpery pvc Ø 38 mm Ral 6005 zelená	38/1,50	1,00		5,10	6,12
	38/2,00	1,50		6,90	8,28
	38/2,50	2,00		8,25	9,90
Spinky OMEGA 50 Antracit	50/1,50	1,00		7,35	8,82
	50/2,00	1,25-1,50		9,55	11,46
Stěpíky OMEGA 48 Antracit 48 mm	48/1,70	1,00-1,20		9,30	11,16
	48/2,00	1,50		10,90	13,08
	48/2,30	1,50		12,50	15,00
Kruhové vzpery pvc Antracit	38/2,00	1,00-1,20		7,60	9,12
	38/2,00	1,50		7,60	9,12
Spinky Omega á 150 mm	prichytávanie pletiva na stěpík Omega			0,09	0,11
Kliešte Omega				41,00	49,20

Na objednávku je možné dodať aj iné dĺžky stěpíkov a vzpier.

Príslušenstvo :

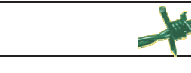
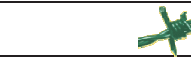
Pätka na stěpík /vzperu	Zn / pvc zelená		10,50	12,60
Podhrabová doska dĺžka/výška/šírka v mm	2490/250/35		15,00	18,00
	2590/250/35		16,00	19,20
	2490/500/35		28,00	33,60
Držiak podhrab. dosky v=20 cm	plast Ø 50 mm		2,80	3,36
	hliník Ø 48 mm		7,00	8,40
Nádstavec/bavolet/ Zn iba 48 mm !!!	jednostranný I		7,50	9,00
	obojsstranný V		15,00	18,00
Nádstavec/bavolet/ pvc iba 48 mm !!!	jednostranný I		8,50	10,20
	obojsstranný V		17,00	20,40
Ostnatý drôt Zn	Ø 1,8/2,00 - 50 m		8,50	10,20
	Ø 1,8/2,00 - 100 m		14,00	16,80
	Ø 1,8/2,00 - 250 m		30,50	36,60
Ostnatý drôt pvc	Ø 2,0/2,50 - 50 m		10,50	12,60
	Ø 2,0/2,50 - 100 m		19,00	22,80
Žiletkový drôt Zn	Ø 450 mm - cca 10 bm		22,00	26,40

ZVÁRANÉ PANELE 3D S OHYBOM / 2D ROVNÉ

NÁZOV	Rozmer m	Počet prelisov		Cena v €	
				bez DPH	s DPH 20%
Plotový diel 3D ZN Ultra Light oko 62,5 x 200 mm hr.drôtov 4,2 / 4,2 mm pozinkované	2,50 x 1,03	2		17,00	20,40
	2,50 x 1,23	2		19,50	23,40
	2,50 x 1,53	3		24,00	28,80
	2,50 x 1,73	3		26,50	31,80
Plotový diel 3D ZN Light oko 50 x 200 mm hr.drôtov 4,0 / 4,0 mm	2,50 x 1,20	2		18,50	22,20
	2,50 x 1,36	4		22,00	26,40
	2,50 x 1,56	4		24,50	29,40
	2,50 x 1,76	4		27,00	32,40
Plotový diel 3D ZN Štandard oko 50 x 200 mm hr.drôtov 5,0 / 5,0 mm pozinkované na obj. výšky 0,63 ; 1,53 2,16 ; 2,36 ; 2,43 ; 2,56 m	2,50 x 0,80	2		21,50	25,80
	2,50 x 1,00	2		24,00	28,80
	2,50 x 1,20	2		28,00	33,60
	2,50 x 1,40	2		32,00	38,40
	2,50 x 1,60	2		35,50	42,60
	2,50 x 1,76	4		38,50	46,20
Plotový diel 2D ZN Štandard oko 50 x 200 mm hr.drôtov 2x6,0/5,0 mm pozinkované	2,50 x 1,03	rovný		35,00	42,00
	2,50 x 1,23	rovný		42,00	50,40
	2,50 x 1,43	rovný		47,50	57,00
	2,50 x 1,63	rovný		53,00	63,60
	2,50 x 1,83	rovný		58,00	69,60
Plotový diel 3D PVC Ultra Light oko 60 x 200 mm hr.drôtov 4,4 / 4,4 mm Ral 6005 zelená	2,50 x 0,855	2		10,50	12,60
	2,50 x 1,025	2		12,50	15,00
	2,50 x 1,225	2		14,50	17,40
	2,50 x 1,585	4		20,00	24,00
	2,50 x 1,785	4		22,00	26,40
Plotový diel 3D PVC Light oko 50 x 200 mm hr.drôtov 4,0/4,0 mm zelená * antracit na obj.	2,50 x 0,98	2		15,50	18,60
	2,50 x 1,18	2		17,50	21,00
	2,50 x 1,46	3		22,50	27,00
	2,50 x 1,74	4		24,50	29,40
	2,50 x 1,94	4		29,50	35,40
Plotový diel 3D PVC Štandard oko 50 x 200 mm hr.drôtov 5,0 / 5,0 mm zelená * antracit na obj.	2,60 x 0,98	2		22,00	26,40
	2,60 x 1,18	2		26,00	31,20
	2,60 x 1,46	3		31,50	37,80
	2,60 x 1,74	4		37,50	45,00
Plotový diel 2D PVC Štandard oko 50 x 200 mm hr.drôtov 2x6,0/5,0 mm Ral 6005 zelená * sklado na obj.výšky 0,63;0,83;2,23	2,50 x 1,03	rovný		34,50	41,40
	2,50 x 1,23	rovný		41,00	49,20
	2,50 x 1,43	rovný		46,50	55,80
	2,50 x 1,63	rovný		52,50	63,00
	2,50 x 1,83	rovný		58,50	70,20
2,50 x 2,03	rovný	63,26	75,91		
2,50 x 2,43	rovný	80,00	96,00		

Na vyžiadanie je možné dodať iné výšky,oká a farby /za priplatok/.

STĹPIKY /k zváraným panelom /

NÁZOV	Ø / dĺžka mm/m	Výšk.opl. m		Cena v €	
				bez DPH	s DPH 20%
ALFA Zn 48 / k panelom 3D Zn Ultra Light /	48/1,75	1,03-1,23		5,50	6,60
	48/2,10	1,53-1,73		6,50	7,80
	48/2,40	2,03		7,10	8,52
Príchyť.panela+skrutka	* á 0,40-0,60 m			0,50	0,60
JOKEL 64 Zn 60x40 mm /k panelom 3D Zn Light /	60x40/2,00	1,20-1,36		10,60	12,72
	60x40/2,20	1,56		11,60	13,92
	60x40/2,40	1,76		12,70	15,24
Príchyťka Inox-rohová	* á 0,4-0,6 m			1,50	1,80
Príchyťka Inox-priebežná				1,50	1,80
Príchyťka Inox-koncová				1,50	1,80
JOKEL 66 Zn Štandard 60x60 mm / k panelom 3D ZN Štandard,2D ZN /	60x60/1,70	1,00-1,20		14,00	16,80
	60x60/2,00	1,40-1,50		16,00	19,20
	60x60/2,20	1,60-1,70		18,50	22,20
	60x60/2,40	1,80		20,00	24,00
	60x60/2,60	2,03		21,00	25,20
	60x60/2,80			23,00	27,60
60x60/3,00		25,00	30,00		
60x60/3,20	2,43		26,00	31,20	
Príchyťka pvc s krytkou Skrutka	* á 0,40-0,60 m			0,60	0,72
				0,40	0,48
ALFA 48 pvc / k panelom 3D pvc Ultra Light /	48/1,50	0,855-1,025		4,80	5,76
	48/1,75	1,225		5,60	6,72
	48/2,20	1,585		6,80	8,16
	48/2,30	1,785		7,10	8,52
48/2,60	2,085		8,00	9,60	
Príchyťka.panela+skrutka	* á 0,40-0,60 m			1,75	2,10
OMEGA pvc 50 / k pan.3D pvc Light a 3D pvc Štandard /	50/1,50	0,98		6,70	8,04
	50/1,75	1,18		7,70	9,24
	50/2,00	1,46		8,70	10,44
	50/2,25	1,74		9,70	11,64
50/2,50	1,94		10,70	12,84	
Príchyťky Omega 50 pvc	* á 0,40-0,60 m			1,25	1,50
JOKEL 64 pvc 60x40 mm /k panelom 3D pvc Light a 3D Štandard,2D /	60x40/1,80	0,98-1,18		8,10	9,72
	60x40/2,00	1,46		8,90	10,68
	60x40/2,20	1,74		10,50	12,60
	60x40/2,40	1,94		11,00	13,20
60x40/2,60	1,94		12,00	14,40	
Príchyťka pvc 60x40 mm	* á 0,40-0,60 m			1,25	1,50
H stĺpik pvc / k panelom 3D pvc Light a 3D Štandard,2D /	1,60	0,98-1,18		11,30	13,56
	2,00	1,46		13,90	16,68
	2,20	1,74		15,30	18,36
	2,40	1,94		16,60	19,92
2,60	1,94		17,90	21,48	
Úchyt H stĺpik Skrutka H stĺpik	4-10 ks/panel 2 ks /stĺpik			0,35	0,42
				0,40	0,48

Iné stĺpiky a spôsoby uchytenia na vyžiadanie.

Ostatné príslušenstvo /bavolety na stĺpiky Alfa a Omega,úchyty bet.dosiek/pvc,Al/na tieto stĺpiky,betónové podhrabové dosky,ostatné drôty a žiletkové drôty /v príslušenstve kruhových stĺpikov a kruhových stĺpikov s nosom. ... Str.2 a 4 .

BRÁNY A BRÁNKY krídlové záhradné

NÁZOV	Výška brány/m/		Cena v €		Cena v €	
			bez DPH	s DPH 20%	bez DPH	s DPH 20%
Bránka 1-krídlová 1K KLASIK pvc výplň 4-hran Ral 6005 zelená	1,00		110,00	132,00	120,00	144,00
	1,25		115,00	138,00	125,00	150,00
	1,50		125,00	150,00	130,00	156,00
	1,60		130,00	156,00		
	1,80		140,00	168,00	160,00	192,00
FAB zámok	2,00		145,00	174,00	165,00	198,00
š=1,00 m	š=1,00 m					
Brána 2-krídlová 2K KLASIK pvc výplň 4-hran Ral 6005 zelená	1,00		200,00	240,00	240,00	288,00
	1,25		210,00	252,00	245,00	294,00
	1,50		220,00	264,00	255,00	306,00
	1,60		225,00	270,00		
	1,80		230,00	276,00	275,00	330,00
visiaci zám	2,00		240,00	288,00	295,00	354,00
š=3,60 m	š=3,60 m					
Bránka 1-krídlová 1K FORTE ZN výplň zvar 50x50 mm ZN	1,00		140,00	168,00	155,00	186,00
	1,25		155,00	186,00	170,00	204,00
	1,50		170,00	204,00	185,00	222,00
	1,60		175,00	210,00	190,00	228,00
	1,80		190,00	228,00	205,00	246,00
so zámkom /bez vložky/	2,00		210,00	252,00	225,00	270,00
š=1,00 m	š=1,25 m					
Brána 2-krídlová 2K FORTE ZN výplň zvar 50x50 mm ZN	1,00		340,00	408,00	390,00	468,00
	1,25		365,00	438,00	415,00	498,00
	1,50		385,00	462,00	455,00	546,00
	1,60		405,00	486,00	490,00	588,00
	1,80		475,00	570,00	575,00	690,00
so zámkom /bez vložky/	2,00		495,00	594,00	720,00	864,00
š=3,00 m	š=4,00 m					
Bránka 1-krídlová 1K FORTE pvc výplň zvar 50x50 mm PVC Ral 6005 zelená	1,00		180,00	216,00	190,00	228,00
	1,25		195,00	234,00	205,00	246,00
	1,50		225,00	270,00	235,00	282,00
	1,60		230,00	276,00	240,00	288,00
	1,80		240,00	288,00	260,00	312,00
so zámkom /bez vložky/	2,00		250,00	300,00	290,00	348,00
š=1,00 m	š=1,25 m					
Brána 2-krídlová 2K FORTE pvc výplň zvar 50x50 mm PVC	1,00		345,00	414,00	405,00	486,00
	1,25		375,00	450,00	445,00	534,00
	1,50		410,00	492,00	485,00	582,00
	1,60		455,00	546,00	545,00	654,00
	1,80		585,00	702,00	710,00	852,00
so zámkom /bez vložky/	2,00		650,00	780,00	770,00	924,00
š=3,00 m	š=4,00 m					
Bránka 1K Brána 2K STRONG pvc výplň zvar 50x200 mm Ral 6005 zelená	1,00		170,00	204,00	395,00	474,00
	1,25		180,00	216,00	400,00	480,00
	1,50		190,00	228,00	435,00	522,00
	1,60		210,00	252,00	485,00	582,00
	1,80		215,00	258,00	490,00	588,00
š=1,00 m	š=3,50 m					
Bránka 1K Brána 2K ESPACE pvc výplň jokel Ral 6005 zelená	1,00		185,00	222,00	465,00	558,00
	1,25		200,00	240,00	505,00	606,00
	1,50		215,00	258,00	525,00	630,00
	1,75		235,00	282,00	565,00	678,00
	2,00		250,00	300,00	690,00	828,00
š=1,00 m	š=3,50 m					

BRÁNKY A BRÁNY S MOŽNOSŤOU MOTORIZÁCIE /na objednávku/

Výška brány/m/	Šírka brány	Cena v €	
		bez DPH	s DPH
1,00		275,00	330,00
1,25		290,00	348,00
1,50		305,00	366,00
1,60		340,00	408,00
1,75		350,00	420,00
2,00			
Bránka 1-krídlová 1K ŠTANDARD výplň: jokel ... 5x5 ... 5x20 farba Ral 6005 zelená iná farba + 5%			

záмок Locinox

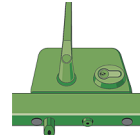

Výška brány/m/	Šírka brány	Cena v €	
		bez DPH	s DPH
1,00		405,00	486,00
1,20		450,00	540,00
1,50		510,00	612,00
1,60		580,00	696,00
1,80		640,00	768,00
2,00			
Brána 2-krídlová 2K Štandard výplň jokel ... 5x5 ... 5x20 farba Ral 6005 zelená iná farba + 5%			
1,00		535,00	642,00
1,20		580,00	696,00
1,50		630,00	756,00
1,60		685,00	822,00
1,80		740,00	888,00
2,00			
Brána posuvná na kofajnici BPK výplň jokel ... 5x5 ... 5x20 farba Ral 6005 zelená iná farba + 5%			
1,00		685,00	822,00
1,20		730,00	876,00
1,50		780,00	936,00
1,60		835,00	1002,00
1,80		890,00	1068,00
2,00			
Brána posuvná samonosná BPS výplň jokel ... 5x5 ... 5x20 farba Ral 6005 zelená iná farba + 5%			
1,00		770,00	924,00
1,20		815,00	978,00
1,50		860,00	1032,00
1,60		915,00	1098,00
1,80		970,00	1164,00
2,00			

CENY NA VYŽIADANIE

Iné rozmery brán na objednávku
Zostava elektroponov

Doplňky k bránam :



Zostava závor

Turnikety



www.predajplotov.sk - tel: 0918 240 615 - Teplička 263, 052 01 Sp.N. Ves - info@predajplotov.sk

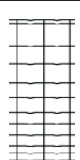

UZLOVÉ PLETIVÁ

NÁZOV	Výška m	Počet dr. ks	Dĺžka rol. m		Cena za bm v €		Cena za bm v €	
					bez DPH	s DPH 20%	bez DPH	s DPH 20%
UZLOVÉ ZN	1,00	11	50		0,70	0,84	0,85	1,02
Štandard	1,15	12	50		0,75	0,90	0,90	1,08
vnútorný / vodiaci drôt	1,25	13	50		0,80	0,96	0,95	1,14
2,00 / 2,80 mm	1,40	14	50		0,90	1,08	1,05	1,26
Light	1,50	14	50		0,90	1,08	1,05	1,26
1,80 / 2,20 mm	1,60	15	50		0,95	1,14	1,10	1,32
	1,75	16	50		1,00	1,20	1,15	1,38
	1,80	18	50		1,05	1,26	1,25	1,50
šírka oka 150 mm	2,00	19	50	Det. 	1,10	1,32	1,30	1,56
	2,20	20	50		1,15	1,38	1,45	1,74

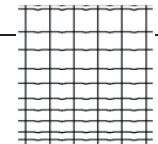
DIALNIČNÉ PLETIVÁ / zvráané /

NÁZOV	Výška m	Počet dr. ks	Dĺžka rol. m		Cena za bm v €
DIALNIČNÉ PVC zvrá.	1,60	15	50		1,95 2,34
dr. 1,8/2,10 mm	2,00	17	50		2,30 2,76
DIALNIČNÉ ZN zvrá.	1,00	10	50		0,85 1,02
ZN	1,20	12	50		0,95 1,14
šírka oka 150 mm	1,50	14	50		1,10 1,32
priemer drôtu 2,00 mm	1,80	16	50		1,25 1,50
	2,00	18	50		1,35 1,62

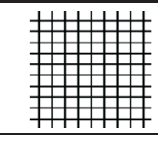
CHOVATEĽSKÉ PLETIVÁ /zvráané + pletené/

NÁZOV	Výška m	Okó mm	Hr.drôtu mm	Dĺžka rol. m		Cena za bm v €	
						bez DPH	s DPH 20%
VOLIÉRA ZVAR ZN	1,00	13 x 13	0,8	25		1,20	1,44
zvráaná sieť	1,00	16 x 16	1,2	25		2,05	2,46
	1,00	19 x 19	1,4	25		2,20	2,64
	1,00	25 x 25	1,4	25		2,40	2,88
	1,00	25 x 25	2,0	25		3,15	3,78
VOLIÉRA ZVAR PVC	1,00	25 x 25	2,3	25		3,70	4,44
VOLIÉRA 4-hran ZN	1,00	10 x 10	1,4	10		4,70	5,64
pletená sieť/4-hran/	1,00	12 x 12	1,4	10		5,60	6,72
	1,00 *	16 x 16	1,4	10		3,15	3,78
	1,00 *	16 x 16	1,6	10		4,00	4,80
* možnosť dodať aj vo výške 1,60 m/bal.25m/	1,00 *	20 x 20	1,6	10		2,90	3,48
	1,00 *	20 x 20	2,0	10		4,00	4,80

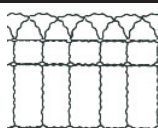

OKRASNÉ PLETIVO/pletené/

NÁZOV	Výška m	Dĺžka rol. m		Cena za bm v €	
				bez DPH	s DPH 20%
DEKOR PVC	0,25	25 m		0,75	0,90
oko 90x150 mm	0,40	25 m		0,95	1,14
Ø drôtu 2,4/3,0 mm	0,65	25 m		1,20	1,44
Ral 6005 zelená	0,90	25 m		1,45	1,74
	1,20	25 m		1,75	2,10

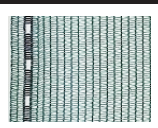

RUČNÝ VRTÁK

NÁZOV	Ø	Cena za ks v €
Ručný vrták	Ø 150 mm	35,00 42,00

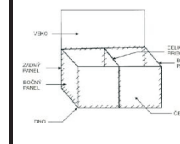
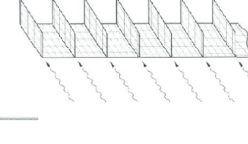

TIENIACE SIETE

NÁZOV	Výška/dĺžka roľky /m/	Cena za roľku v €			Výška/dĺžka roľky /m/	Cena za roľku v €	
		bez DPH	s DPH 20%			bez DPH	s DPH 20%
LIGHTTEX	1,00/10	8,60	10,32		1,00/50	33,50	40,20
80 % nepriehľadnosť	1,20/10	10,50	12,60		1,20/50	40,80	48,96
90 g / m ²	1,50/10	12,90	15,48		1,50/50	50,50	60,60
farba zelená	1,80/10	15,50	18,60		1,80/50	60,60	72,72
	2,00/10	17,50	21,00		2,00/50	68,00	81,60
MEDIUMTEX	1,00/10	13,50	16,20		1,00/50	58,50	70,20
90 % nepriehľadnosť	1,20/10	16,00	19,20		1,20/50	68,00	81,60
160 g / m ²	1,50/10	20,50	24,60		1,50/50	84,90	101,88
farba zelená	1,80/10	24,00	28,80		1,50/50*	120,00	144,00
	1,80/10	24,00	28,80		1,80/50	95,00	114,00
* krémová farba	2,00/10	27,00	32,40		1,80/50*	143,00	171,60
	2,00/10*	36,00	43,20		2,00/50	115,00	138,00
	2,00/10*	36,00	43,20		2,00/50*	159,00	190,80
GOLDTEX	1,00/10	18,50	22,20		1,00/50	84,00	100,80
95 % nepriehľadnosť	1,20/10	22,00	26,40		1,20/50	101,00	121,20
230 g / m ²	1,50/10	27,50	33,00		1,50/50	84,00	100,80
farba zelená	1,80/10	33,00	39,60		1,80/50	155,00	186,00
	2,00/10	36,00	43,20		2,00/50	170,00	204,00
Klip Fixatec na tieniacu sieť						0,35	0,42





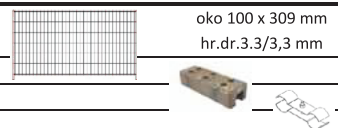

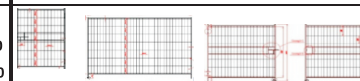







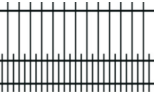

GABIÓNY /ekokoše/

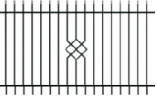
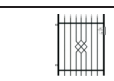
NÁZOV	Rozmer m	Cena za ks v €			Rozmer m	Cena za ks v €	
		bez DPH	s DPH 20%			bez DPH	s DPH 20%
Blok/zvrá.sieť/	0,5 x 0,5	2,80	3,36		1,0 x 1,0	6,70	8,04
oko 100 x 100 mm	1,0 x 0,5	3,50	4,20		1,5 x 1,0	9,90	11,88
hr.drôtu 4,00 mm	1,5 x 0,5	5,20	6,24		2,0 x 1,0	13,20	15,84
	2,0 x 0,5	6,70	8,04		2,5 x 1,0	16,30	19,56
	2,5 x 0,5	8,40	10,08		3,0 x 1,0	19,60	23,52
	3,0 x 0,5	10,20	12,24				
Spojovacia špirála	0,60					0,35	0,42
	1,10					0,60	0,72
	1,60					0,90	1,08
	2,10					1,20	1,44
Dištančné ťahlo	0,50					0,25	0,30
	1,00					0,30	0,36

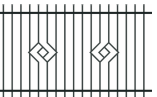



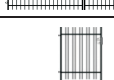



MOBILNÉ OPLOTENIE

NÁZOV	Rozmer mm		Cena za ks v €	
			bez DPH	s DPH 20%
Mobilný diel ZN Light	3 450 x 2 000 mm	oko 100 x 309 mm hr.dr.3.3/3,3 mm	44,00	52,80
Plastový podstavec	800 x 290 x 125 mm		12,00	14,40
Spona ZN			1,50	1,80
Vzpera ZN			11,50	13,80
Kolík pre vzperu ZN			4,00	4,80
Brány mob.opl. ZN	1K 1 450 x2 000 m		80,00	96,00
s pántom	1K+ koliesko 3 450x2 000		75,00	90,00
	2K + koliesko 4 000x2 000		210,00	252,00

MODERNÉ PANELOVÉ OPLATENIE

NÁZOV	Rozmer š x v	Rozmer profilov	1K bránka š=1,00 m		Samonosná brána š=4,00 m	Cena za panel v €		
			2K brána š=4,00 m			bez DPH	s DPH 20%	
AGÁT 	2,50x1,00	vodorovný				74,00	88,80	
	2,50x1,10	25 x 25 mm				79,00	94,80	
	2,50x1,20	zvislý				84,00	100,80	
	2,50x1,30	15 x 15 mm				89,00	106,80	
	2,50x1,40	á 112,2 mm				94,00	112,80	
AMETYST 	2,50x1,00	vodorovný				81,00	97,20	
	2,50x1,10	25 x 25 mm				93,00	111,60	
	2,50x1,20	zvislý				99,00	118,80	
	2,50x1,30	15 x 15 mm				104,00	124,80	
	2,50x1,40	á 75/150 mm				109,00	130,80	
RUBÍN 	2,50x1,00	vodorovný				100,00	120,00	
	2,50x1,10	25 x 25 mm				105,00	126,00	
	2,50x1,20	zvislý				110,00	132,00	
	2,50x1,30	15 x 15 mm				116,00	139,20	
	2,50x1,40	á 112,2 mm				121,00	145,20	
SMARAGD 	2,50x1,00	vodorovný				105,00	126,00	
	2,50x1,10	25 x 25 mm				110,00	132,00	
	2,50x1,20	zvislý				116,00	139,20	
	2,50x1,30	15 x 15 mm				121,00	145,20	
	2,50x1,40	á 112,2 mm				126,00	151,20	
ÓNYX 	2,50x1,00	vodorovný				102,00	122,40	
	2,50x1,10	25 x 25 mm				109,00	130,80	
	2,50x1,20	zvislý				116,00	139,20	
	2,50x1,30	15 x 15 mm				123,00	147,60	
	2,50x1,40	á 62/108 mm				129,00	154,80	
POVRCHOVÁ ÚPRAVA	DUPLIX / žiarové pozinkovanie + farba / ... žiarové pozinkovanie bez farby - 10%							
ŠTANDARDNÉ FARBY	Ral 9005 čierna	Ral 6005 zelená	Ral 7016 šedá	Ral 7024 šedá	Ral 7030 hnedá	Ral 8017 hnedá	Modern brown	Antracit

STĹPIKY A PRÍSLUŠENSTVO

Stĺpiky k panelom, brámkam a bránam	Rozmer st. mm	Typ stĺpika	Cena € za bm! stĺpika		*** 	NÁZOV	Cena za ks v €			
			bez DPH	s DPH			rozmer	bez DPH	s DPH 20%	
dĺžka stĺpikov :	60 x 60 x 2	panel/bránka	15,20	18,24		Príchytky k panelom 25x25/15x15	1,70	2,04		
h panela + 0,60 m	80 x 80 x 2	panel/bránka	20,80	24,96						
h bránky + 0,80 m	100x100x3	bránka/brána	36,60	43,92						
h brány + 0,90 m	120x120x3	brána	43,80	52,56						
		 C1 kov	 C2 kov	 C3 kov	 C4 plast					
		bez DPH	s DPH 20%	bez DPH	s DPH 20%	bez DPH	s DPH 20%	bez DPH	s DPH 20%	
ČIAPOČKY na stĺpiky			7,60	9,12	4,70	5,64	2,70	3,24	1,00	1,20
			11,20	13,44	5,00	6,00	3,30	3,96	1,70	2,04
			17,80	21,36	6,60	7,92	4,30	5,16	2,70	3,24
			19,80	23,76	8,30	9,96	5,30	6,36	4,00	4,80
HROT na panel	P-1		P-2		P-4		G-2		Príplatok € za bm	
								bez DPH	s DPH 20%	
agát, smaragd, rubín								9,60	11,52	
ametyst 2x								14,50	17,40	
onyx								12,60	15,12	



lesa
predaj plotov a brán